

REVISION HISTORY		
REV	DATE	APPROVED
0	2/28/2012	MZ

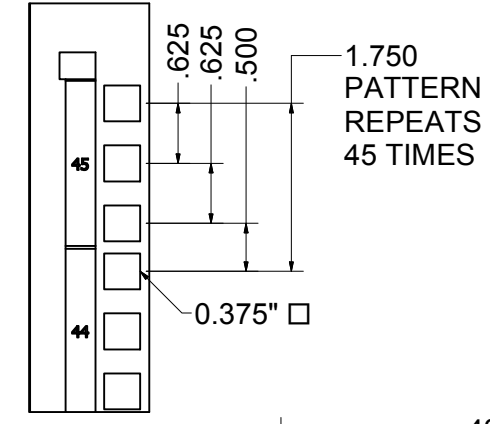

DETAIL C
RAIL DETAIL

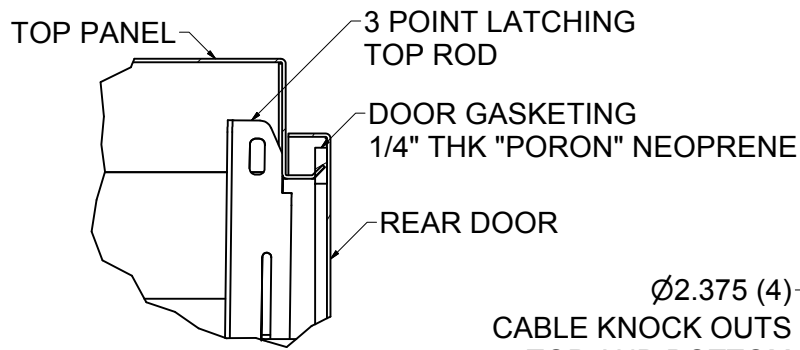

DETAIL D

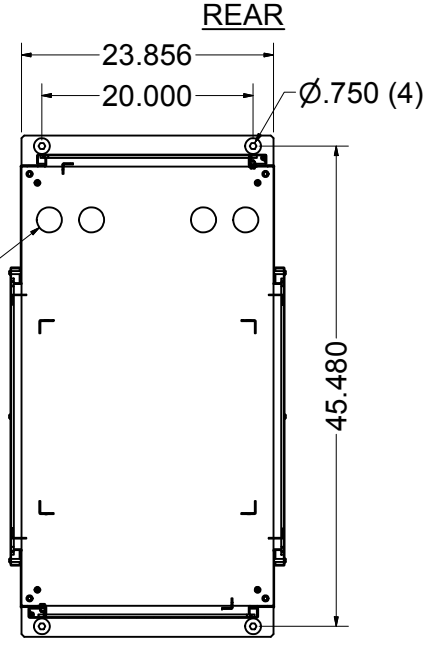

SECTION B-B
TOP AND BOTTOM

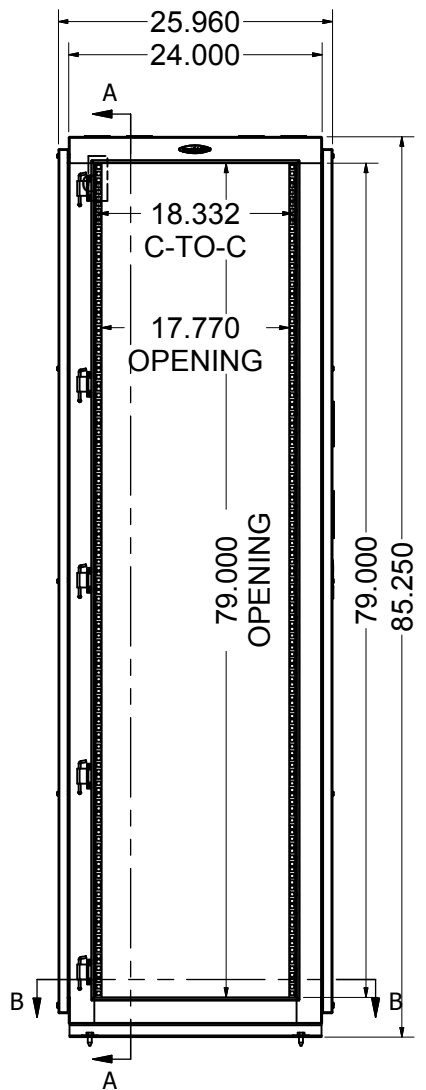
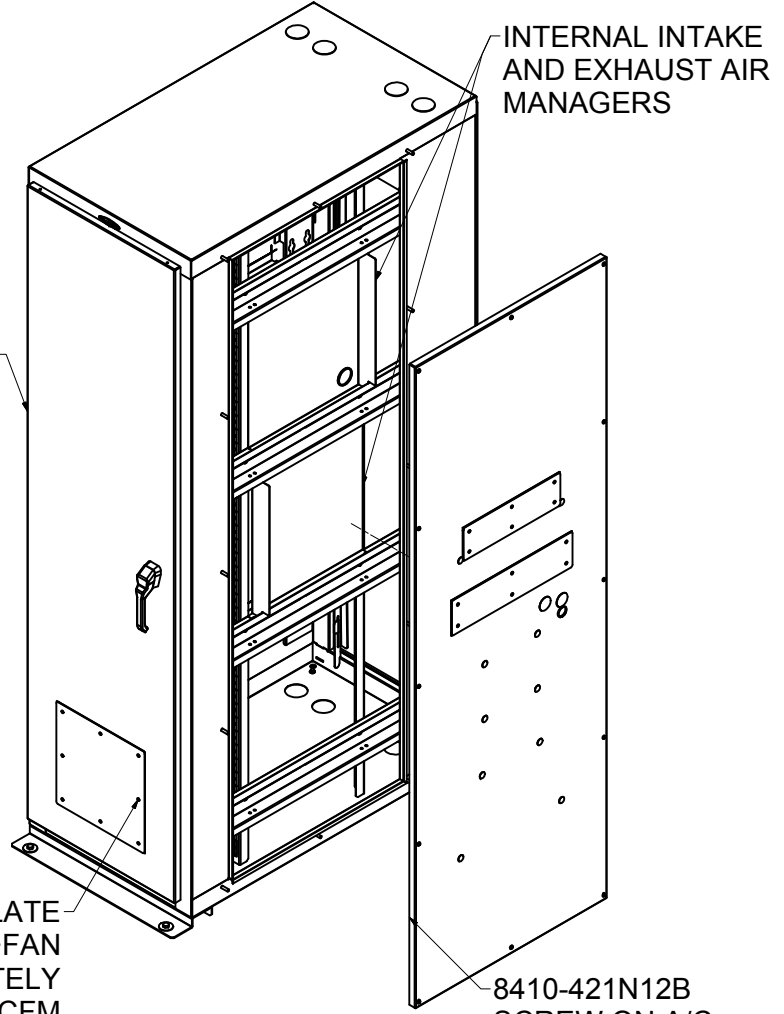

FRONT VIEW
DOORS REMOVED FOR CLARITY

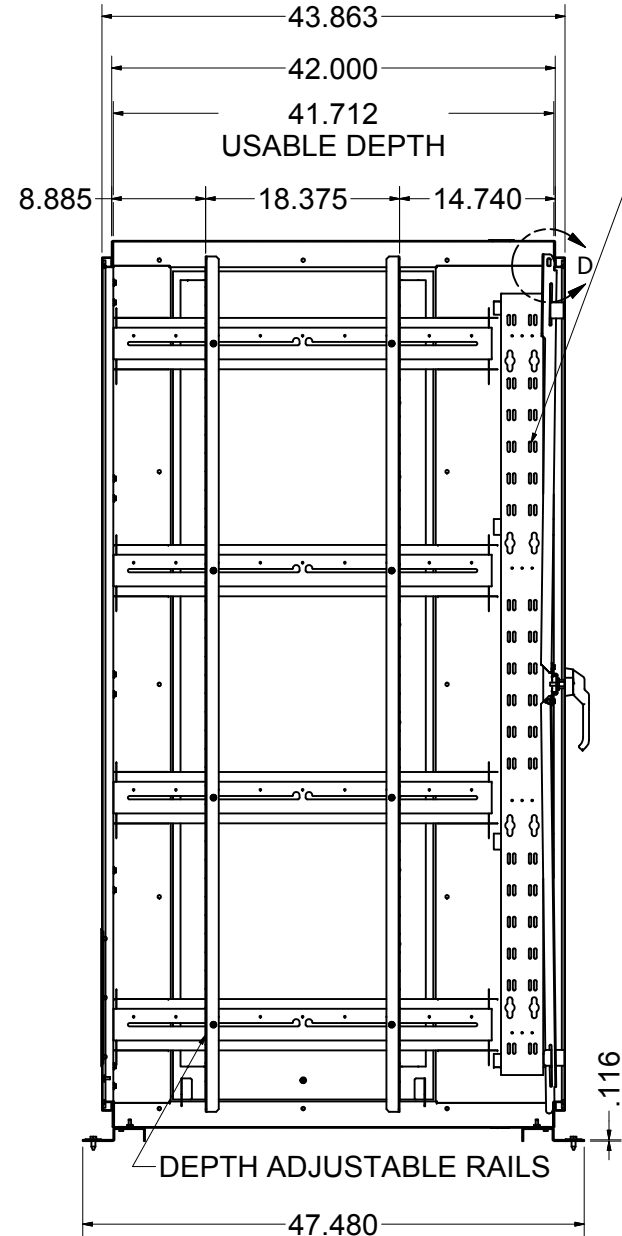

SECTION A-A

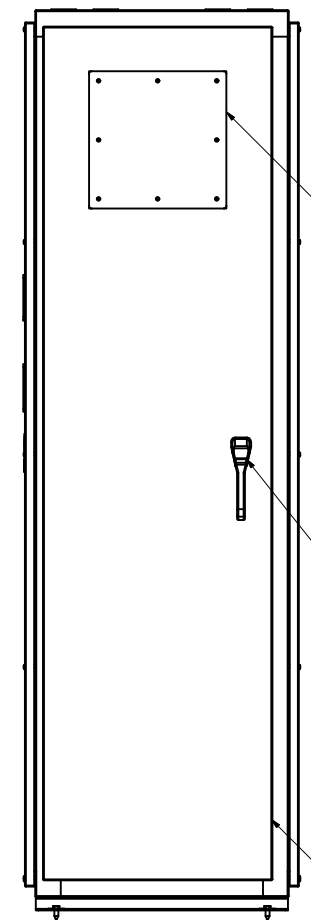

REAR VIEW

REAR EXHAUST GLAND PLATE
OPTIONAL NEMA-12 EXHAUST FILTER
SOLD SEPARATELY

FRONT INTAKE GLAND PLATE
OPTIONAL NEMA-12 FILTER +FAN
SOLD SEPARATELY
AVAILABLE IN 230, 295, OR 368 CFM

SPECIFICATIONS:

RACK SPACES: 19" E 310-E COMPLIANT, 3/8" SQ. HOLE w/ RMU LABELS.

WEIGHT CAPACITY: 2000 LBS. (BOLTED TO FLOOR)

COLOR: DURABLE BLACK TEXTURE POWDER COAT.

RATING: NEMA-12

CONSTRUCTION: #11 GAUGE ANCHOR PLATES
#12 GAUGE MOUNTING RAILS
#14 GAUGE WELDED BODY AND DOORS

HARDWARE: PACKAGE OF QTY-50 METRIC 6mm SCREWS & CAGE NUTS INCLUDED.

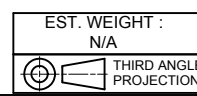

INTERPRET DRAWING PER ASME Y14.5M-1994
DIMENSIONAL LIMITS APPLY AFTER APPLICATION OF FINISH
DRAWING NOT TO SCALE
TOLERANCE UNLESS OTHERWISE NOTED:
ANGULAR +/- .1°
.XXXX +/- .010
.XXX +/- .015
.XX +/- .030
.X FOR REF. ONLY
UNLESS OTHERWISE SPECIFIED ALL DIMENSIONS ARE IN INCHES

NOTICE:
Use of this document is subject to a confidentiality and nondisclosure agreement with Great Lakes Case & Cabinet Co., Inc. (GLCC) and may not be reproduced, disclosed or utilized in whole or in part without prior written authorization from GLCC.

PART NUMBER: GL840N12-2442-SB
QTY PER UNIT: 1
MATERIAL TYPE:
MATERIAL GAUGE:
FINISH:
DRAWN MZ
DATE 2/28/2012
CHECKED & APP. WSS
DATE 2/28/2012

TITLE 84"H x 24"W x 42"D NEMA 12 ENCLOSURE WITH REMOVABLE SIDE PANEL FOR IQ8000VHA, IQ10000V & 12000V
GREAT LAKES CASE & CABINET CO., INC. P.O. BOX 551 EDINBORO, PA 16412 PHONE (814) 734-7303 FAX (814) 734-3907 E-MAIL glcc@greatcabinets.com
DWG NO. GL840N12
REV 0
SHEET: 1 OF 1