



IP Office

2420/5420 Phone User Guide

Notice

While reasonable efforts were made to ensure that the information in this document was complete and accurate at the time of printing, Avaya Inc. can assume no liability for any errors. Changes and corrections to the information in this document may be incorporated in future releases.

Documentation Disclaimer

Avaya Inc. is not responsible for any modifications, additions, or deletions to the original published version of this documentation unless such modifications, additions, or deletions were performed by Avaya.

Link Disclaimer

Avaya Inc. is not responsible for the contents or reliability of any linked Web sites referenced elsewhere within this Documentation, and Avaya does not necessarily endorse the products, services, or information described or offered within them. We cannot guarantee that these links will work all of the time and we have no control over the availability of the linked pages.

License

USE OR INSTALLATION OF THE PRODUCT INDICATES THE END USER'S ACCEPTANCE OF THE TERMS SET FORTH HEREIN AND THE GENERAL LICENSE TERMS AVAILABLE ON THE AVAYA WEBSITE AT <http://support.avaya.com/LicenseInfo/> ("GENERAL LICENSE TERMS"). IF YOU DO NOT WISH TO BE BOUND BY THESE TERMS, YOU MUST RETURN THE PRODUCT(S) TO THE POINT OF PURCHASE WITHIN TEN (10) DAYS OF DELIVERY FOR A REFUND OR CREDIT.

Avaya grants End User a license within the scope of the license types described below. The applicable number of licenses and units of capacity for which the license is granted will be one (1), unless a different number of licenses or units of capacity is specified in the Documentation or other materials available to End User. "Designated Processor" means a single stand-alone computing device. "Server" means a Designated Processor that hosts a software application to be accessed by multiple users. "Software" means the computer programs in object code, originally licensed by Avaya and ultimately utilized by End User, whether as stand-alone Products or pre-installed on Hardware. "Hardware" means the standard hardware Products, originally sold by Avaya and ultimately utilized by End User.

License Type(s): Designated System(s) License (DS).

End User may install and use each copy of the Software on only one Designated Processor, unless a different number of Designated Processors is indicated in the Documentation or other materials available to End User. Avaya may require the Designated Processor(s) to be identified by type, serial number, feature key, location or other specific designation, or to be provided by End User to Avaya through electronic means established by Avaya specifically for this purpose.

Copyright

Except where expressly stated otherwise, the Product is protected by copyright and other laws respecting proprietary rights. Unauthorized reproduction, transfer, and or use can be a criminal, as well as a civil, offense under the applicable law.

Third-Party Components

Certain software programs or portions thereof included in the Product may contain software distributed under third party agreements ("Third Party Components"), which may contain terms that expand or limit rights to use certain portions of the Product ("Third Party Terms"). Information identifying Third Party Components and the Third Party Terms that apply to them is available on Avaya's web site at: <http://support.avaya.com/ThirdPartyLicense/>

Avaya Fraud Intervention

If you suspect that you are being victimized by toll fraud and you need technical assistance or support, call Technical Service Center Toll Fraud Intervention Hotline at +1-800-643-2353 for the United States and Canada. Suspected security vulnerabilities with Avaya Products should be reported to Avaya by sending mail to: securityalerts@avaya.com. For additional support telephone numbers, see the Avaya Support web site (<http://www.avaya.com/support>).

Trademarks

Avaya and the Avaya logo are registered trademarks of Avaya Inc. in the United States of America and other jurisdictions. Unless otherwise provided in this document, marks identified by "®," "TM" and "SM" are registered marks, trademarks and service marks, respectively, of Avaya Inc. All other trademarks are the property of their respective owners.

Documentation information

For the most current versions of documentation, go to the Avaya Support web site (<http://www.avaya.com/support>) or the IP Office Knowledge Base (<http://marketingtools.avaya.com/knowledgebase/>).

Avaya Support

Avaya provides a telephone number for you to use to report problems or to ask questions about your contact center. The support telephone number is 1 800 628 2888 in the United States. For additional support telephone numbers, see the Avaya Web site: <http://www.avaya.com/support>.

Contents

1. The Telephone

1.1 Call Appearance Keys.....	8
1.2 Call Appearance Key Icons.....	9
1.3 System Features.....	9
1.4 Logging Off.....	10
1.5 Logging On.....	10
1.6 No User	11
1.7 The Display.....	11

2. Basic Call Handling Features

2.1 Answering a Call.....	14
2.2 Making a Call.....	15
2.3 Clearing a Call.....	15
2.4 Conference.....	16
2.5 Transfer	16
2.6 Headset Working.....	17
2.7 Speakerphone.....	18
2.8 Speed Dial.....	19
2.9 Redial	19
2.10 Mute	20
2.11 Hold	20
2.12 Message	21
2.13 Private Call.....	21

3. Using Speed Dials

3.1 Adding a New Speed Dial.....	25
3.2 Dialling a Speed Dial Number.....	26
3.3 Deleting a Speed Dial.....	26
3.4 Editing a Speed Dial.....	26
3.5 Converting a Call Log Entry to a Speed Dial.....	26

4. Using Visual Voice

4.1 Listen to Voicemails.....	29
4.2 Send a Voicemail.....	30
4.3 Changing Your Greeting.....	31
4.4 Changing Your Mailbox Password.....	32
4.5 Email Alerts.....	33
4.6 Voicemail Transfer.....	33

5. Using the Call Log

5.1 Setting Which Calls are Logged.....	37
5.2 Viewing the Call Log.....	37
5.3 Making Calls from the Call Log.....	38
5.4 Saving a Call Log Entry to Your Speed Dial List.....	38
5.5 Deleting a Call Log Entry.....	39
5.6 Erasing All Logged Calls.....	39

6. Changing Options

6.1 Ring Options.....	42
6.2 Adjusting the Display Contrast.....	43
6.3 Call Log Setup.....	43
6.4 Miscellaneous.....	43
6.5 Using Self Test.....	44
6.6 Default Phone/Erase All Settings.....	44
6.7 Language	45
6.8 Automatic Gain Control (AGC).....	45

7. Function Keys

7.1 Overview of the Function Keys.....	48
7.2 Display Mode.....	49
7.3 Function Key Programming.....	50
7.4 Shorthand Programming Mode.....	52
7.5 Longhand Programming.....	53
7.6 Changing Function Key Labels.....	54

8. System Features

8.1 Introduction.....	56
8.2 Ring Back	56
8.3 Call Forwarding.....	56
8.4 Diverting Calls.....	57
8.5 Do Not Disturb.....	58
8.6 Parking Calls.....	58
8.7 Voicemail	59
8.8 Default Feature Codes.....	60

9. EU24 Expansion Module

9.1 EU24 Overview	62
9.2 Connection.....	63
9.3 Using the EU24 Expansion Module.....	63
Index	65

Chapter 1.

The Telephone

1. The Telephone

This guide covers the use of the 2420 and 5420 phones on IP Office. Both phones are similar, however the 5420 is only supported on the IP Office whereas the 2420 is supported on a range of Avaya phone systems.



1. Display, Call Appearance and Feature Buttons: Call Appearance keys enable you to handle multiple calls and the display shows call information. Details on system features (allocated by your system administrator) can also be displayed. See [Call Appearance Keys](#)^[87] and [Overview of the Function Keys](#)^[48].
2. Message Lamp: The lamp is used as follows:
 - On (Continuous): There are new messages in your voicemail mailbox, or another mailbox for which you have been configured to receive "Message Waiting Indication".
 - Flashing: The lamp can also be set to flash when the phone receives a call. See [Ring Options](#)^[42].
3. ◀ ▶ Previous/Next Page: Move through the different pages of the call handling, speed dials and call log screens. Also used to move the cursor during data entry.
4. ✉ MESSAGES: Access your mailbox.
5. Call Handling Buttons:
 - 🛑 HOLD: Red button used to place a call on hold.
 - 🔄 TRANSFER: Transfers a call to another phone.
 - 🗨 CONFERENCE: Sets up conference calls with more than one other person.
 - 📵 DROP: Drops the current call or, if on a conference call, drops the last person to join the conference.
 - 🔄 REDIAL: Redials the last number dialed or displays the last 6 numbers dialed from the phone, depending on configuration via the Options menu.
6. Dial Pad: Standard 12-button pad for dialling phone numbers.
7. ▼▲ Volume Controls: Adjust the speaker, handset, headset, or ringer volume depending on which is currently in use.
8. 🚫 MUTE: Turns the microphone on/off. When in use, the associated light is on and the caller cannot hear you.
9. 🎧 HEADSET: Switches from handset to headset. The light associated with this button turns on when the headset is active.
10. 📢 SPEAKER: Access the speakerphone. The light associated with this button turns on when the speakerphone is active. The handset is muted while the speaker or headset is in use.
11. ➡️ EXIT: Returns you to the main call handling screen.
12. Softkeys : Used to navigate to or initiate certain features, such as Speed Dial or Call Log, as well as control certain actions within the features. These keys correspond to the text prompts in the display screen immediately above them.

1.1 Call Appearance Keys

Normally, the first page of the main call handling screen contains three keys set as 'call appearance' keys. These are allocated to you by your system administrator and are indicated as a=, b= and c=. An underscored call appearance key (e.g. a=) indicates that the line is active.

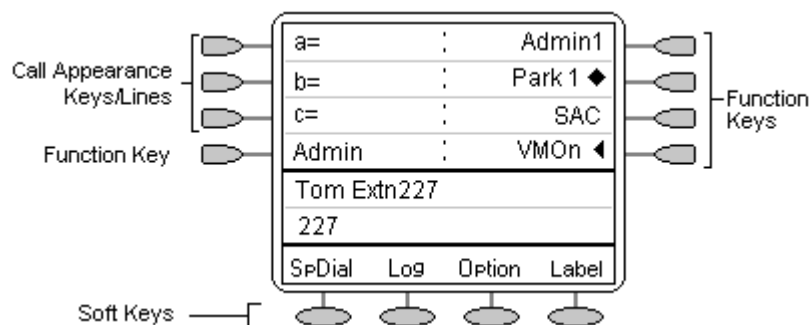

Your system administrator can allocate a call appearance key with:

- A Bridged Appearance
A bridged appearance key matches the status and operation of the call appearance key on a pre-defined colleague's phone. Hence, you can pick-up, make and receive calls on behalf of your colleague.
- A Line Appearance
An IP Office exchange line (but not IP lines) can be allocated to you such that the status of that line is displayed and you can use the line appearance key to make and receive calls.
- Call Coverage Appearance
A call coverage appearance key alerts you when a pre-defined colleague is receiving a call. The covered user does not need to be using call appearance keys. Hence, you can pick-up calls on behalf of your colleague.

For details of Bridged, Line and Call Coverage Appearance keys set-up and their operation, refer the IP Office Key and Lamp Operation manual.

Having more than two call appearance keys is very useful. When holding a call, you can answer or make another call and then switch between calls, transfer or conference. If you are set to receive call waiting indication, the waiting call is shown against the next call appearance key.











Caution

- Although the system administrator can replace the call appearance keys with Bridged, Line and Call Coverage Appearance keys, this would severely restrict the use of features such as conference and transfer.

It is for this reason that it is strongly recommended that all call appearance keys remain at their default settings.

1.2 Call Appearance Key Icons

The icons displayed against the Call Appearance/Feature keys, allow you to determine the status (for example, on  HOLD) of each call. Icons also indicate whether a feature has been activated for a particular button.

- Incoming Call: 
A  symbol next to a call appearance key indicates an incoming call.
- Connected: 
A  symbol next to a call appearance key indicates that it is the currently connected call. The caller's phone number (if available) is also shown. To put the call on hold, press  HOLD. An H is displayed.
- On HOLD: 
A  symbol next to a call appearance key indicates a call on hold. To take the call off hold and put any other current call on hold, press  .
- Function Active:  
The button to the left or right of the function key is active.

1.3 System Features

System Features can only be set against soft Function Keys by your system administrator. However, your system administrator may allocate you two 'self administrator' features that will enable you to add System Features to your soft Function Keys.

In addition, there are a number of System Features that you can always access yourself by the use of short codes. Refer to [System Features Introduction](#)^[56] for details of System Features that you can always access yourself by dialling short codes. For example, to listen to your voicemail messages, dial *17.

1.4 Logging Off

If you have been allocated a login code, you can log your phone off to prevent unauthorized use during an absence, or for privacy purposes.

If you are logging off from another extension, the system will log you back in at your home extension, unless the force-login option is set.

Caution

- Call Log entries and certain Speed Dial settings will remain on the extension even when you are logged out.

To log off the phone where you had logged on dial *36.

1.5 Logging On

Your administrator has created your initial configuration so that you will be automatically logged on to your home extension. However, you may be required to log in for the following reasons:

- Forced login - if your configuration does not allow automatic login to your home extension.
- To use an extension other than your own (hot desking)
- If you, or somebody else, has logged you out of your extension.

Notes

- When hot desking, any short codes you have setup on your home extension will be passed to the extension you have logged on to.
- Certain information such as speed-dials and call log are telephone model dependent, and will not be passed to the new extension.
- You will be able to hot desk to extensions on remote sites only if the Small Community Advanced Networking License is installed on that system.

To login to your home extension (forced login), enter *35*P#, where 'P' is your login code.

To login at another extension (hot desking), enter *35*N*P#, where 'N' is your home extension number and 'P' is your login code.

Notes

- Your login code, if configured, will be supplied by your Administrator.
- You have 4 attempts at logging on. If you fail to logon correctly, the message "Invalid" will be shown on the main display and you will hear the busy tone. If you fail all 4 attempts to log on, you must wait 90 seconds before any login will be accepted, whether correct or not.

1.6 No User

The NoUser configuration will be used for extensions where the home user is not currently logged on for example:

- The home user is logged on to another extension
- Forced login is enabled

An extension set as NoUser will display the name "NoUser" and the extension number.

If required, and you have been allocated a login code, you can logon using your extension number and login code. (see [Logging On](#)^[10])

Note

- Although internal calls may be made from an extension marked NoUser, normally calls cannot be received on that extension.

1.7 The Display

B	Phone Locked: Internal calls only.
D	Call Forwarding On: See Call Forwarding ^[56] .
G	In Group: You can enable/disable group membership.
H	Held Call: Shows the number of held calls. See HOLD ^[20] .
N	Do Not Disturb On: See Do Not Disturb ^[58] .
NoUser	No User: The extension is not currently logged on. see No User ^[11]
O	Out of Hours: This is displayed if one or more Hunt Groups is in "Out-of-Hours" mode.
P	Parked Calls: Shows the number of parked calls.
T	Twinned: The phone is being used as the twin of another phone.
DISC	Disconnected: To end the call, press  SPEAKER.
CONN	Connected: You are on a call.
ssss	Suppressed Code When an account or authorization code is entered, the number you enter is displayed as "ssss" for security purposes.
CONF	CONFERENCE Call: You are part of a conference call, displayed on the left hand side of the display. See CONFERENCE Calls ^[16] .

Chapter 2.

Basic Call Handling Features



2. Basic Call Handling Features

2.1 Answering a Call

When a call arrives at your phone, you hear a ringing tone and a blinking bell icon appears on the associated call appearance.

To answer an incoming call:

Do one of the following:

- If you are not active on another call, answer the call using your handset, headset or speakerphone (see [Speakerphone](#) ^[18]).
- If you are active on a call already, place the active call on hold (see [Hold](#) ^[20]), and then answer the incoming call.
- If the call appearance for the ringing call is not displayed on the current screen page, press  EXIT to return to the first page of the Home screen. When you locate the call appearance for the ringing call, press the corresponding call appearance button.
- If you are a member of a hunt group, you will see a blinking bell icon next to your group name, for example "Sales ". Press  Sales to answer the call.

Note

- To redirect an incoming call, do not answer, press  DROP to redirect the call to Forward On No Answer (if set) or voicemail (if available).

To answer a call at another extension:

You can answer from your own phone by using Call Pick-Up; lift your handset and dial:

- *30 to answer a call ringing anywhere.
- *31 to answer a call within your group.
- *32*201# to answer the call for a particular extension, in this example 201.

The default ring cadences are:

- Internal calls - single ring cadence.
- External calls - double ring cadence.

These can be changed by your system administrator.



Note

- If your phone rings for any longer than a specified period (15 seconds in default), any re-direction feature that you have activated, such as voicemail or call forwarding, will come into effect.

2.2 Making a Call

You can make calls from the phone using a variety of methods as follows:

To manually make a call:

1. Lift the handset and dial the required number on the key pad. Remember to include the required access code (for example; 9 for an outside line) and listen to the progress of the call.
2. Adjust the speakerphone volume as necessary.
To change the volume, press ▼ and ▲. The eight volume levels are displayed.
3. If the call is not answered, press  SPEAKER or  DROP.
If the call is answered, either speak or pick up the handset and speak to the called party.

To automatically make a call:

Do any of the following:

- To have the phone dial the last number that you dialed, press  REDIAL and then press the function key associated with the call. See [Redial](#) ^[19].
- Access the Call Log and initiate a call to a specific entry. See [Making Calls from the Call Log](#) ^[38].
- Access the Speed Dial List in your personal directory and initiate a call to a specific entry. See [Dialling a Speed Dial Number](#) ^[26].

When the call is answered, either speak or pick up the handset and speak to the called party.

2.3 Clearing a Call

To clear an established call:

Either:

- Replace the handset.
or
- Press  DROP.

2.4 Conference

The Conference feature allows you to conference other parties (including yourself) into a call.

Notes

- The number of parties allowed in a conference is controlled by your phone system.
- Two Call Appearance keys are required for the conference feature.

To add another party to a call:

1. Press **CONF** CONFERENCE.
2. Dial the number of the person you want to add to the call.
3. To add the person to the call, press **CONF** CONFERENCE again.
If the called party does not answer or does not want to join the conference, press **CONF** DROP. To return to the held call, press **CONF** adjacent to the held call.
4. Repeat steps 1 through 5 for additional conference connections.

To see the details of the different participants in the conference, press **PREV** and **NEXT** Prev/Next.

Notes

- To leave a conference call, hang up.
- To display which conference participants to drop from the conference, press **CONF** DROP. You can then select the participant to drop by pressing the **PREV** and **NEXT** Prev/Next buttons to display the participant, then press **CONF** DROP again.

2.5 Transfer

This feature allows you to transfer a call from your phone to another extension or outside number.

1. With a call in progress, press **CONF** TRANSFER.
2. When you hear dial tone, dial the number to which the call is to be transferred. Then do one of the following:
 - To transfer the call without announcing it (an unsupervised transfer), press **CONF** TRANSFER again. The transfer is complete.
 - To announce the call before transferring it (a supervised transfer), wait for the called party to answer:
 - If the called party is willing to accept the call, press **CONF** TRANSFER again to complete the transfer.
 - If the called party does not wish to accept the call or there is no answer, press **CONF** DROP. To return to the held call, press **CONF** adjacent to it.



2.6 Headset Working

When a headset is to be used, it must be plugged in to the headset socket on the base of the phone. To activate the headset and switch off the handset, press  HEADSET. The lamp beside the button is illuminated when headset working is activated.

To answer an incoming call:

1. Press  HEADSET.

If you are already on a call:

- Place the first call on hold
- Press  next to the flashing bell icon (.

To clear a headset call:

- Press  DROP.



To manually make a call:

- Press  HEADSET.
- Dial the number. Remember to include the required access code (for example; 9 for an outside line) and listen to the progress of the call.

To automatically make a call:

- Press  HEADSET.

Do any of the following:

- Press  REDIAL and then press  to have the phone dial the last number that you dialed. See [Redial](#) ^[19].
- Access the Call Log and initiate a call to a specific entry. See [Making Calls from the Call Log](#) ^[38].
- Access the Speed Dial List in your personal directory and initiate a call to a specific entry. See [Dialling a Speed Dial Number](#) ^[26].

When the call is answered, speak to the called party.



2.7 Speakerphone

The two-way built-in speakerphone allows you to make and answer calls without lifting your handset. Keep in mind that two-way speakerphones may not operate satisfactorily in every environment (such as in very noisy locations).

- For IP Office 4.1 and higher, the Group Listen function can be used to hear a call via the speaker but talk through the handset. Consult your System Administrator for more details.

To make or answer a call without lifting the handset, or to use the speakerphone with any feature:

1. Press  SPEAKER. The LED beside the button illuminates.
2. Make or answer the call, or access the selected feature.

Adjust the speakerphone volume if necessary. To change the volume, press  and . The eight volume levels are displayed.

To change from the speakerphone to the handset (or headset if fitted):

- Pick up the handset (or press  HEADSET) and talk.

To change from the handset to the speakerphone:

- Press  SPEAKER and hang up the handset.



To end a speakerphone call:

- Press  SPEAKER again.



2.8 Speed Dial

The Speed Dial feature enables you to automatically dial calls to phone numbers stored in your personal directory. For more information about the Speed Dial facility, see Using Speed Dials.

To make a call to a personal directory entry using the Speed Dial feature:

1. From the Home screen, press any  Soft Key.
2. From the Home screen, press  SpDial. The Speed Dial screen is displayed.
3. Press the button next to the entry you want to call.

Note

- If the entry you want is not displayed, press  and  to search through the entries or key the first letter of the required name to jump to the page with a matching entry.

The phone dials the number for you.





2.9 Redial

The Redial feature automatically redials a previously dialed extension or outside number (up to 24 digits). Your phone will store up to ten of the last numbers dialed.

Note

- If you have dialed the same number twice in succession, it will only have one appearance in the redial list.

To redial a previously dialed number:

- Press  REDIAL and then press  and  to search through the entries. When you have located the required number, press the associated  button next to the number.



To redial the last number dialed:

- Press  REDIAL twice.

2.10 Mute

During an active call, the Mute feature prevents the party (with whom you are speaking) from hearing you. This feature is most commonly used in conjunction with the Speakerphone. However, it can be used to hold an off-line conversation at any time during a call.



To prevent the other person on the line from hearing you:

1. Press  MUTE. The indicator next to the Mute button lights when Mute is active.
2. To reinstate two-way conversation, press  MUTE again.

2.11 Hold

You can put a call on hold to gather information, or to answer a second call. If a second call arrives you will here a short ring and the flashing  symbol will appear next to the Call Appearance key.





To put an existing call on hold:

1. Press  HOLD.
2. Answer the second call by pressing the call appearance button with the  symbol against it. The symbol changes to ; showing that the line is connected.

To return to the held call:

1. If you have a call in progress, then first put that call on hold as above.
2. To retrieve a held call, press the Call Appearance button with  against it.

Notes

- With hold return timer (defined by your system administrator), you are reminded that you have a call on hold. The phone will ring and  is displayed.
- If the system feature *AutoHold* is on (consult your system administrator) then you can hold an active call () by pressing () against the second call. If *AutoHold* is off, then pressing () against the second call, will drop the first call.

2.12 Message

 Message is used to access the voicemail system (if installed). Once pressed, the prompts given will depend on the type of voicemail system. For further details, refer to the Mailbox Users Guides provided for the different voicemail systems supported by IP Office.

The message lamp at the top of the phone stays lit when there are new messages in your voicemail mailbox, or in any other mailbox for which you have been configured to receive "Message Waiting Indication".

Note

- The lamp can also be set to flash when the phone is rung, irrespective of whether you have new messages waiting to be read.

2.13 Private Call

The Private Call feature is used to prevent any intrusions during the call. Private call can be activated either before or during a call and will set the phone status to 'cannot be intruded' until you switch the Private Call feature off.

If you place a call to an extension with Private Call on, you will hear the Number Unobtainable tone.



Note

- Private call is not a default feature. If you require this option, contact your administrator.





Chapter 3.

Using Speed Dials

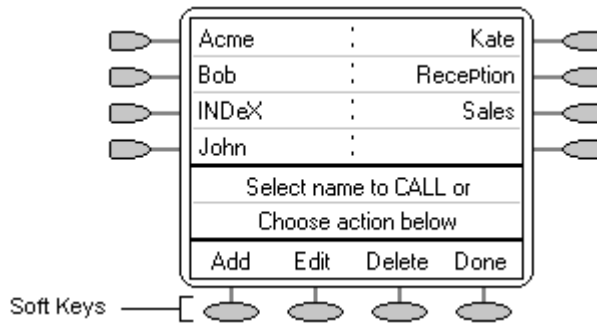
3. Using Speed Dials

The phone can store up to 104 personal speed dials. For a list of the speed dials, press any  and then press  SpDial. To exit the current screen, press  EXIT.



- The speed dial list is sorted alphabetically.
- To move between pages, press  and .
- Press the appropriate letter key to move direct to the first page with a matching name.
- To call the number, press  or  next to an entry.
- To perform other actions, press .

To access the details of a particular speed dial, press the soft key and select the name from the directory.

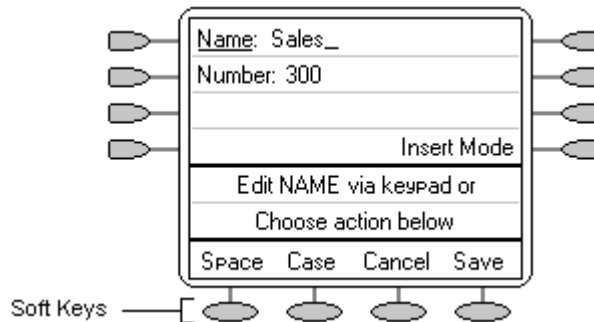

Note

- Speed dials can be used for any numbers that can be manually dialed from the extension. Where a dialling prefix is required (for example, an external line access digit) then that prefix must be part of the speed dial number.

3.1 Adding a New Speed Dial

To add a new speed dial:

1. Press SpDial. If SpDial is not shown and to exit the current screen, press EXIT and then press Add. If a message appears stating that the speed dial list is full, you must first delete an existing entry before adding any new entry. See [Deleting a Speed Dial](#) ²⁶.

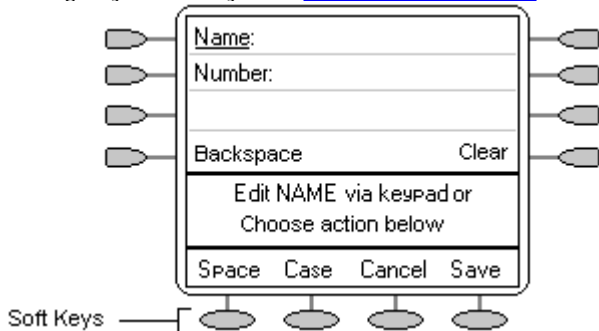







To switch between Name and Number entry, press next to the item you want to edit. The options also change accordingly.

2. With Name selected, begin entering text using the telephone keypad. Each key is marked with the letters and number it provides. You may have to press the key more than once depending on the character you require. For example:
 - The key 2 is also marked as A, B and C. To enter a C, press 2 until C is displayed.
 - If the next character you want to enter is on the same key, press to move the cursor right and then enter the character.
 - By default the first letter is entered in upper-case and the phone then switches to lower-case entry mode. To change the case of the current character, press .
 - To enter a space, press .
 - If you make a mistake, press Backspace to delete the character to the left of the cursor.
 - If you have made a mistake in the middle of a character string and do not wish to backspace and re-enter all the characters, press to step back to one character before the point where you wish to edit. Either insert the new character or press Backspace to delete the character to the left of the cursor.
 - Press * once enters a . (period) or twice a * (asterisk). To enter more than one * (asterisk) or . (period), press to move the cursor to the right and then enter the character.
 - Press # once enters a - (dash) or twice enters a # (hash). To enter more than one # (hash) or - (dash), press to move the cursor to the right and then enter the character.
3. When the name is set as required, press Number.
4. Enter the number required using the dialling keypad. For external numbers remember to enter any external dialling prefix required (e.g. 9).
 - To enter a hyphen, press Hyphen. This does not affect the number dialed but may help make numbers more readable.
 - To enter a 1.5 second pause, press Pause. This will appear as a , (comma) character in the phone number.
 - To move the cursor left or right, press and .
5. To save the speed dial and return to the speed dial list, press Save.
6. To return to the speed dial list without saving the changes, press Cancel.
7. To return to the call handling screen without saving the changes, press EXIT.

3.2 Dialling a Speed Dial Number











You can use the speed dial directory to make a call with the handset on hook or off hook.

To dial a speed dial number:

1. Press  SpDial. If  SpDial is not shown and to exit the current screen, press  EXIT.
2. To display different pages of speed dials, press  and  or key the first letter of the required name to jump to the page with a matching entry.
3. When the required entry is displayed, press the adjacent  or .









3.3 Deleting a Speed Dial

To delete a speed dial:

1. Press  SpDial. If  SpDial is not shown and to exit the current screen, press  EXIT.
2. Press  Delete.
3. Select the speed dial entry you want to delete. To display different pages of speed dials, press  and  or key the first letter of the required name to jump to the page with a matching entry.
4. When the required entry is displayed, press the adjacent  or . A request for confirmation will appear.
5. To delete the entry, press  Yes or, to exit without deleting, press  Cancel.
6. Select another entry to delete or to return to the speed dial list, press  Done.

3.4 Editing a Speed Dial

To edit a speed dial:

1. Press  SpDial. If  SpDial is not shown and to exit the current screen, press  EXIT.
2. Press  Edit.
3. Select the speed dial entry you want to edit. To display different pages of speed dials, press  and  or key the first letter of the required name to jump to the page with a matching entry.
4. When the required entry is displayed, press the adjacent  or .
5. Edit the speed dial using the same methods as for adding a new speed dial. See [Adding a New Speed Dial](#) ^[25].
6. After saving or canceling any changes you will be returned to the speed dial selection list. Select another speed dial to edit or to return to the speed dial list, press  Done.

3.5 Converting a Call Log Entry to a Speed Dial

You can create a new speed dial from a call log entry. See [Saving a Call Log Entry to Your Speed Dial List](#) ^[38].

This process will start the normal speed entry screen but pre-filled with the name and number from the call log entry.

Chapter 4.

Using Visual Voice

4. Using Visual Voice

Visual Voice gives you access to your mailbox using softkeys and, by using the associated feature keys, a more user-friendly option control.

Visual Voice is accessed by pressing  Voice and then selecting from the displayed options:



- Listen - You can have direct access to your voicemail.
- Message - You can leave a message directly in a mailbox you specify.
- Greeting - You can listen to, change or delete your greeting message.
- Password - You can change your voicemail password
- Email - You can view or change your email alert status;
- <Group> - You can have direct access to voicemails for any group you are a member of; if you are the Group Mailbox Administrator.

Note

- The email option is only available if VoiceMail Pro is installed, and Voicemail Email has been configured for you.

4.1 Listen to Voicemails

To listen to your Voicemails or your Group Voicemails:

1. Press  Voice.
2. Press  Listen (for your messages) or  <group name> (for your hunt group messages), for example, Sales (25).
3. When prompted, key in the password. If your extension has been configured as a trusted source, the password will not be required.
Note - If you do not have the required password, contact your administrator.

You will be presented with the following message categories for your messages:

- New (5)
- Old (7)
- Saved (13)





Note - The total number of messages in each category is displayed in brackets.

4. Use the feature key to select the category, for example  New.

The first message in the selected category will play and the following message handling feature key options are displayed:

- Next - Plays next message.
- << - rewinds current message by 5 sec
- >> - fast forwards current message by 5 sec
- Pause- pauses the current message/resumes playing
- Delete - Delete the current message.
- Save - Change the current message's category to 'saved'
- Previous - Plays previous message
- Copy- Copy the message to another mailbox or mailboxes. If selecting more than one mailbox, the entries must be separated with a #.

To add a covering message to the copied voicemail.





1. Press  Copy, and add the recipients. The feature keys change to the copy options.
2. Press  Pre-Rec
3. Record your message
4. Press  Stop
5. Press  Listen to check your message. You can change the message by selecting Pre-Rec again.
6. Press  Send.

Note

- Depending on the number of feature keys available, you may need to use the scrolling facility to see all of the options.

4.2 Send a Voicemail

To send a message to another person or Group:

1. Press  Voice.
2. Press  Message and dial the extension of the person or Group.
3. Press  Message again. The soft-key Record is displayed.
4. Press  Record. The Stop soft-key is displayed.
5. Record your message and when finished, press  Stop.

After recording your message, the following soft-key options are displayed:

- Listen - Listen to the message you just recorded.
- Record - Re-record your message.
- Others - Add other recipients; each entry separated by a #. Then press  Done.
- Submit - Submit (send) the message.

When you have submitted your message, press  EXIT to return to the main display.



4.3 Changing Your Greeting

You can listen to, change and save your current greeting.

Note

- Visual Voice only modifies your Personal Greeting for All Calls.





To change your mailbox greeting:

1. Press  Voice.
2. Press  Greeting. The following options are then displayed on the soft-keys.
 - Record - starts recording.
 - Listen - to hear your current greeting.
 - Submit - saves the new greeting.
 - Delete - deletes your current greeting.

To listen to your current Greeting:

1. Press  Listen.

To Record a new Greeting:



1. Press  Record. The Stop soft-key is then displayed.
2. Record your Greeting and then press  Stop.
3. Press  Listen to hear the message you have just recorded; re-record if you are not satisfied with the Greeting.
4. Press  Submit to save the new Greeting.
5. Press  EXIT to return to the main display.

4.4 Changing Your Mailbox Password

Note

- When changing your mailbox password it is advisable not to use sequential numbers (1234, 6789, 8765, etc.) or existing extension numbers.

To change your Mailbox password:

1. Press  Voice.
2. Press  Password.
3. When prompted, key in your new password (minimum of 4 digits) and press  Done.











The display will exit to the main display if the change was accepted. Otherwise you will be prompted to try again.

4.5 Email Alerts

The Email option is displayed if:

- You have Voicemail pro installed
and
- Voicemail Email has been configured for you.



To view or change the current email alert status:

1. Press  Voice.
2. Press  Email. You will be prompted for your current voicemail password.
The current voicemail email alert status is shown along with Change and Done soft-keys.
3. Select either:
 -  Done - To exit leaving the current alert status active
 -  Change - To change the status.Note - The  Change soft-key will toggle through the alert status, beginning with the current status.
4. Chose one of the following status:
 -  OFF - No email alerts are sent.
 -  COPY - An email alert is sent with a copy of the voicemail attached.
 -  FWD - An email alert is sent with a copy of the voicemail attached. The original voicemail is deleted from your voicemail mailbox.
 -  ALERT- An email alert is sent when there is a new voicemail.
5. When you have made you selection, press  Done

4.6 Voicemail Transfer

Unlike the standard transfer, Voicemail Transfer allows you to transfer a call to another user's mailbox.

To transfer the call to another mailbox:

1. Press  Voice.
2. Key in the user's extension number.
3. Press  Vmail Transfer.

The call will be transferred directly to the users mailbox; the extension is not alerted.

Chapter 5.

Using the Call Log

5. Using the Call Log

The phone maintains a call log, to access, press Log. This log can store up to 100 entries. These can be a combination of incoming answered calls, incoming unanswered (missed) calls and outgoing calls.

You can select which types of calls are included in the log. You can also use call log entries to make return calls or convert the entry into a speed dial for future use.

WARNING

- Calls that are made using pin codes and other information will appear in the call log. Either Logging of outgoing calls should be switched off or those call logs removed manually. See [Setting Which Calls are Logged](#) ³⁷.

Notes

- Only outgoing calls made using the dial pad or a speed dial entry are logged.
- Call log entries are lost if the phone is disconnected from the IP Office.

To display a screen similar to the following, press Log:

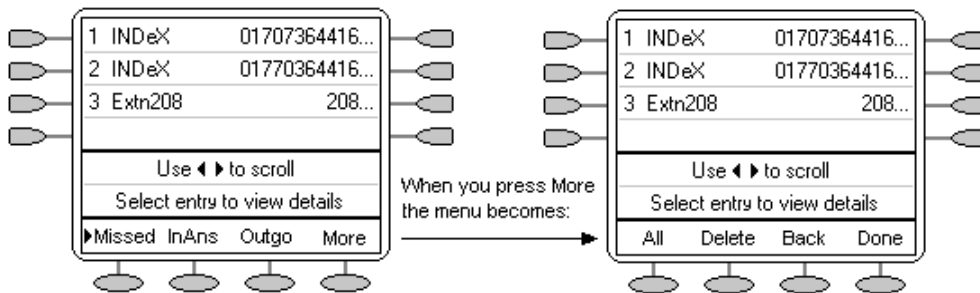

- Missed calls are displayed first. You can select from InAns or Outgo. Alternatively, to display all three options, press More and then select All.
- Logged calls are shown with the most recent first.
- The name of the called or calling party is shown, if available.
- The number of the called or calling party is shown.
- To display further pages of entries, press and .
- To display further details of a particular call, press or next to a log entry.

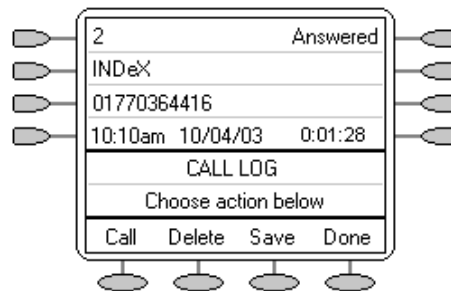

- The number of the log entry.
- The type of log entry, i.e. Answered, Un-answered or Outgoing.
- The name of the called or calling party is shown (if available).
- The number of the called or calling party is shown.
- The date, time and duration of the call.
- To display the previous or next logged call, press and .
- The keys provide a number of actions.

Using The Call Log









You can make calls directly from the call log. Whilst in the call log you can still make a call by going off-hook, press  SPEAKER and dial a new call. Similarly, you can still receive calls and handle them using the dial pad key functions.

5.1 Setting Which Calls are Logged

Caution





- If you change these settings, any call details already in the call log that no longer match the selection are deleted.

To set which calls are logged:

1. Press  Option. If  Option is not shown, press  EXIT to exit the current screen.
2. Press  Log Setup.
A menu showing  Answered,  Un-Answered and  Outgoing, with their current settings is displayed.
3. To toggle a particular setting between Yes or No, press  next to it.













Alternatively;

To underline a call type's current setting, press  next to it. To change the value of the currently underlined setting, press Yes/No.

4. Do one of the following:
 - To save the settings and return to the options menu, press  Save. You will hear a confirmation tone.
Note
If you press  Save after changing the settings, any existing call log entries that do not match the call types selected are deleted from the call log.
 - To return to the  Options menu without saving any changes, press  Cancel.
 - To return to the call handling screen without saving any changes, press  EXIT.

5.2 Viewing the Call Log

To view the call log:

1. Press  Log. If  Log is not shown, press any .
2. At default, Missed calls are displayed first. You can select from InAns or Outgo. Alternatively, press  More and select  All to display all three options. To return to Missed or InAns or Outg, press  Back and make your selection.
3. To display different pages of log entries, press  and .
 - To exit the call log and return to the previous screen, press  Done.
 - To exit the call log and return to the call handling screen, press  EXIT.
 - To view the details of a particular log entry, press  or  next to the entry.
4. To return to the previous screen, press  Done.

5.3 Making Calls from the Call Log

To make a call from the call log:

1. Press Log. If Log is not shown, press any .
2. At default, Missed calls are displayed first. You can select from InAns or Outgo. Alternatively, press More and select All to display all three options. To return to Missed or InAns or Outg, press Back and make your selection.
3. When you locate the entry you want to call, press or next to the entry.
4. To make the call, press Call.
If the number shown is external but does not include the external dialling prefix used by your phone system, go off-hook, dial the prefix and then press Call.

5.4 Saving a Call Log Entry to Your Speed Dial List

To save a call log entry to your speed dial list:

1. Press Log. If Log is not shown press any soft key.
2. At default, Missed calls are displayed first. You can select from InAns or Outgo. Alternatively, press More and select All to display all three options. To return to Missed or InAns or Outg, press Back and make your selection.
3. To display different pages of log entries, press and .
4. When you locate the entry you want to call, press or next to the entry.
5. Press Save. The speed dial editing screen appears, pre-filled with the details from the call log entry. See [Adding a New Speed Dial](#) ^[25].

5.5 Deleting a Call Log Entry

To delete a call log entry:

1. Press Log. If Log is not shown, press any soft key.
2. At default, Missed calls are displayed first. You can select from InAns or Outgo. Alternatively; To display all three options, press More and then select All. To return to Missed or InAns or Outg, press Back and make your selection.
3. To display different pages of log entries, press and .
4. When you locate the entry you want to call, press or next to the entry.
5. Press Delete. The entry is deleted from the Call Log and the details of the next call are shown.
6. To exit the call log and return to the call handling screen, press EXIT.

5.6 Erasing All Logged Calls

Loss of power to the phone will cause all call log entries to be deleted.

The Erase All option deletes the calls you have selected to log. See [Setting Which Calls are Logged](#) [37].

Caution

- This action also deletes all speed dial entries and phone personalization options. See [Default Phone/Erase All Settings](#) [44].

To erase all logged calls:

1. Press Log and then press More.
2. Press Delete. You are presented with a message asking you to confirm that you want to delete all entries.
3. To remove all logged entries, press Erase.

Chapter 6.

Changing Options

6. Changing Options

6.1 Ring Options









The IP Office uses 'distinctive ringing' for different types of calls:

- A repeated single ring for internal calls
- A repeated double ring for external calls
- A single ring followed by two short rings for ringback calls.

These options are fixed by the IP Office. You can personalize your phone's ringer sound so you can recognize it from other ringing phones.

You can choose from among eight different ring sounds. This alters the tone and style of ringing used by the phone, the ring pattern is still controlled by the IP Office according to the call type.



To change the ringer sound:

1. To exit any other mode, press  EXIT and then press  Option.
2. Press  Ring Options and then press  Ring Pattern. A menu with the current ring pattern appears.
3. To select a ringing pattern, press either  and  or press a dial pad key between 1 and 8. You will hear the selected ringing pattern.
4. To hear the ringing pattern again, press  Play or re-press the dial pad key.
 - When you have selected a ringing pattern, press  Save. You will hear a confirmation tone and be returned to the options menu.
 - If you want to return to the options menu without changing the ring pattern, press  Cancel.



Note

- If you receive a call while selecting a ringer sound, you are automatically returned to the Call Handling screen if set (see Show Phone Screen below).

To use the Message Lamp for ringing alerts:

1. To exit any other mode, press  EXIT and then press  Option.
2. Press  Ring Options and set Flash Message Lamp to Yes or No. When set to Yes, the Message lamp will flash when you receive a call. Changing this option does not affect the voicemail visual indicator feature.







To automatically show the Call Handling screen:

1. Press  EXIT to exit any other mode and then press  Option.
2. Press  Ring Options and set Show Phone Screen to Yes or No. If set to Yes then, when you are setting up/using Speed Dial, Call Log, etc., you are automatically returned to the Call Handling screen when you receive a call.

6.2 Adjusting the Display Contrast

You can adjust the contrast level on the phone display. You can choose from among fifteen levels of contrast.

To adjust the display contrast:

1. To exit any other mode, press  EXIT and then press  Option.
2. Press  Contrast. A menu with the current contrast setting appears.
3. To adjust the level of contrast, press  and .
4. When the contrast is set as required, either:
 - To return to the options menu, press  Done.
 - To return to the call handling screen, press  EXIT.



6.3 Call Log Setup

Through the  Option menu, you can specify which types of calls should be included in the phone's call log. See [Setting Which Calls are Logged](#)³⁷.

6.4 Miscellaneous

The Miscellaneous option only contains one menu item: Stay in Speed Dial.







If Stay in Speed Dial is set to Yes and you access your personal Speed Dial list, the menu will remain displayed regardless of any calls made or received.

1. To exit any other mode, press  EXIT and then press  Option.
2. Press  Miscellaneous and set Stay in Speed Dial to Yes.

6.5 Using Self Test

Self test can be used to display information about your phone and to check operation of the lamps and display. The information may be required by your system administrator.







To perform a self test:

1. To exit any other mode, press  EXIT and then press  Option.
2. Press  Self Test. A screen of information is displayed.
3. Press and hold  Test. The screen lines go black and all the phone lamps come on.
4. Do one of the following:
 - To return to the options menu, press  Done.
 - To return to the Call Handling screen, press  EXIT.

6.6 Default Phone/Erase All Settings

The Erase All option, allows you to reset all personalized settings entered through the phone's Option menus (except contrast level). This option also deletes all entries in the phones Call Log and Speed Dial lists.

To erase all settings:

1. To exit any other mode, press  EXIT and then press  Option.
2. Press  Erase.
3. To select/de-select an item for erasure, press  next to an item. A  is shown next to selected items. The items selectable for erasure are:
 - Speed Dials: Selects for erasure all speed dials set in the phone's speed dial store.
 - Call Log: Selects for erasure all entries in the phone's call log.
 - User Labels: Selects for erasure all customized function key labels.
 - Options: Any for erasure or defaulting all other phone options.
 - Language: Selects to default the phone's language setting back to default.
 - All: Selects for erasure or defaulting all of the above.
4. Press  Erase or  Cancel.

6.7 Language









When the phone is first installed, it is set to display screen text in English. You can select the language that you would prefer from the following:

English, German (Deutsch), French (Français), Spanish (Español), Italian (Italiano), Dutch (Nederlands), Portuguese (Português) or Japanese (Katakana characters).

Note

- This does not alter your user language setting on the phone system.











To select a language:

1. To exit any other mode, press  EXIT and then press  Option.
2. Press  Language. A menu listing the available languages appears, with the current language underlined.
3. Press  or  next to the language required. The screen text changes to the language selected.
4. Do one of the following:
 - To save the settings and return to the options menu, press  Save. You will hear a confirmation tone.
 - To return to the options menu without saving any changes, press  Cancel.
 - To return to the call handling screen without saving any changes, press  EXIT.

6.8 Automatic Gain Control (AGC)

Automatic Gain Control (AGC) raises the volume when a caller is speaking quietly and lowers the volume when the caller is loud.

To select Automatic Gain Control:



1. To exit any other mode, press  EXIT and then press  Option.
2. Press  or  until a menu listing the current handset, headset and speaker AGC options is displayed.
3. To toggle a particular setting between Yes and No, press  next to it.
Alternatively:
To underline a call type's current setting, press  next to it. To change the value of the currently underlined setting, press  Yes/No.
4. Do one of the following:
 - To save the settings and return to the options menu, press  Save. You will hear a confirmation tone.
 - To return to the options menu without saving any changes, press  Cancel.
 - To return to the call handling screen without saving any changes, press  EXIT.

Chapter 7.

Function Keys



7. Function Keys



7.1 Overview of the Function Keys

Both ,  function keys and  softkeys can be used to access a range of system features. The display adjacent to the key shows the feature name.





Some of these features are default features supported by the phones (e.g. SpDial, Log, Option and Label on the softkeys) and are always available. Others are system features that can only be programmed by the system administrator for function keys.

In addition, there are a number of system features that you can always access yourself by the use of short codes. Refer to [System Features Introduction](#)^[56] for details of system features that you can always access yourself by dialling short codes, e.g. to listen to your voicemail messages, dial *17.

The main screen has three pages. This means that the eight  and  function keys on each page could be used for up to 24 features. However, it is strongly recommended that all three call appearance keys remain at their default settings. Therefore, there are 21 soft function keys that can be allocated to system features.

To move between pages, press  and .

In the following example:

- The first three keys have been set as call appearance lines.
- Keys 4 and 5 have been set to access the Admin and Admin1 programmable functions.
- Key 6 has been set to monitor system park slot 1. The  indicates a call is currently parked in slot 1.
- Key 7 has been set to the SAC (Send All Calls) function.
- Key 8 has been set to VMOn, a function which toggle use of the voicemail mailbox as on/off. The  indicates that this function is currently on.
- To display the other two pages of programmed functions set for this phone, press either  or .

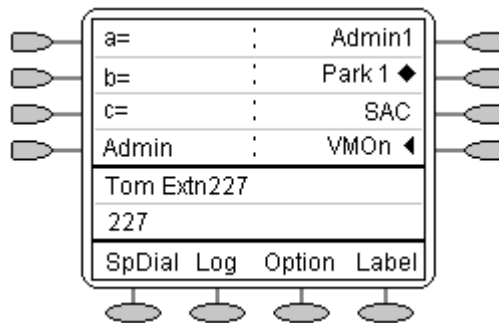

Changing the labels of the function keys:

You can personalize the function key labels. For example, you can change SAC to Send All for instance. See [Changing Function Key Labels](#)^[54].



Programming your own features:

If the phone has been setup with either or both the Admin and Admin1 features assigned to display keys, you can select and program your own feature choices against other keys. See [Function Key Programming](#)^[50].

7.2 Display Mode



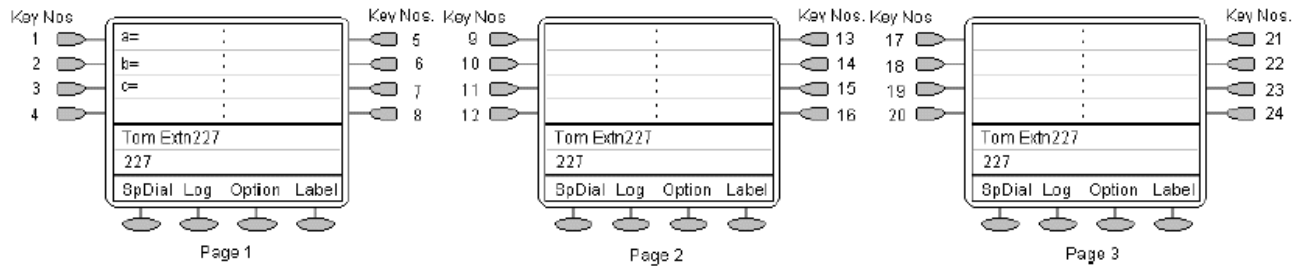

The phone has two display modes. These control the order in which functions are assigned to the display keys. The modes are:

- Normal Mode:

In this mode the 3 pages of  and  are ordered sequentially.  at the base of each page provide the SpDial, Log, Option and Label options.







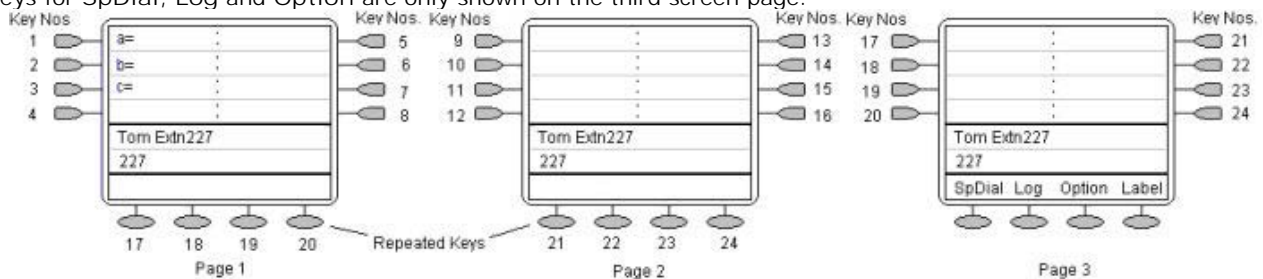



- Call Center Mode:

In this mode some of the  and  functions are repeated against  on the first two screen pages. The  keys for SpDial, Log and Option are only shown on the third screen page.



To change the Display Mode:

- Press  Option. If  Option is not shown, press  EXIT to exit the current screen.
- Press  Display Mode. A menu showing the current setting appears.
- To change the current setting, either press  next to the setting or press  Yes/No.
- Do one of the following:
 - To save the settings and return to the Options menu, press  Save. You will hear a confirmation tone.
 - To return to the Options menu without saving any changes, press  Cancel.
 - To return to the Call Handling screen without saving any changes, press  EXIT.

7.3 Function Key Programming

If any one of the keys on the telephone is programmed with an Admin or Admin 1 feature key, it allows you to program further features against other function keys. Both Admin and Admin1 are allocated to your function keys by your system administrator and will appear on a menu screen that is similar to the following:

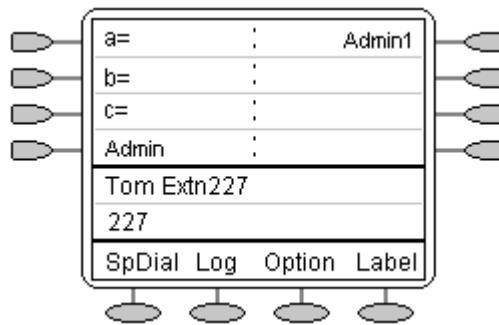

The two tables below list the user programmable features available from Admin and Admin1. For full details of how each function works, see [System Features](#)^[56].

Admin: The programmable functions available via an Admin key are:

<u>Name</u>	<u>Description</u>	<u>Toggles</u>	<u>Data</u>
Acct	Account Code Entry	No	Optional
AD	Abbreviated Dial	No	Yes
Admin	Self-Administer	No	No
AutCB	Automatic Callback	Yes	No
CFrwd	Call Forwarding All	Yes	Optional
CPark	Call Park	Yes	Optional
CPkUp	Call Pickup	No	No
Dir	Directory	No	No
DPkUp	Directed Call Pickup	No	Yes
DROP	DROP	No	No
GrpPg	Group Paging	No	Yes
HdSet	HEADSET Toggle	Yes	No
HfAns	Internal Auto-Answer	Yes	No
HGNS+	Set Hunt Group Night Service	Yes	Yes
Park	Call Park to Other Extension	No	Yes
Prog	Abbreviate Dial Program	No	Yes
RngOf	Ringer Off	Yes	No
SAC	Send All Calls	Yes	No
Spres	AD Suppress	Yes	No
Timer	Timer	Yes	No
TmDay	Time of Day	Yes	No

In addition to the above, there is a key labeled ExPI? This key enables you to change the display from the shorthand version displayed at default to a longhand version of your own. See [Shorthand Programming Mode](#)⁵² and [Longhand Programming](#)⁵³ respectively.

Admin1: The programmable functions available via an Admin1 key.

<u>Name</u>	<u>Description</u>	<u>Toggles</u>	<u>Data</u>
Park	Park	No	Yes
<User>	User	No	Yes
<Group>	Group	No	Yes
<Number>	Dial	No	Yes
Flash	Hook Flash	No	No

7.4 Shorthand Programming Mode

1. Press Admin or Admin 1. See [Function Key Programming](#) ⁵⁰.
2. The Admin or Admin1 menu is displayed, similar to the following:
Admin Pages

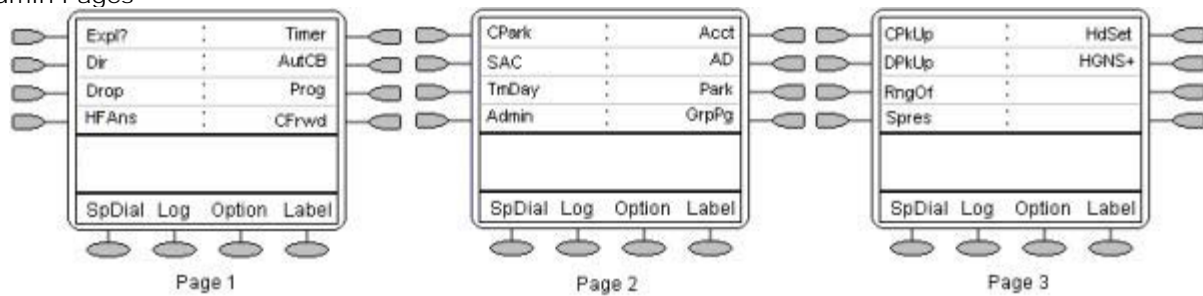





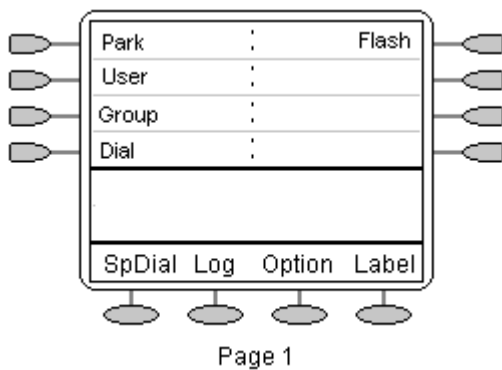





With the exception of Expl?, the names shown are the features that you can assign to soft keys. When Admin has been selected, you can display the full name of the feature by pressing Expl?. See [Longhand Programming](#) ⁵³.

Admin1 Page







3. On the Admin pages, press and to move through the list of feature.
 4. When the function required is shown, press adjacent to its name.
 5. If the function requires some data to be entered, [] is shown at the bottom of the display. Enter the data using the normal phone keypad.
 6. The upper part of the display reverts to showing the functions currently assigned to and .
 7. To select the display key against which to program the new function, press or .
- Caution
- Do not select the slot used for the Admin function. Replacing this function will lock the phone for further programming until reset through the phone system.
8. If the display slot is not already used, the display shows BUTTON PROGRAMMED!.
 - To end programming, press EXIT.
 - To continue programming other functions, press Cont.
 9. Repla, Keep and Delet are shown along the right-hand edge of the display.
 - To replace that existing function with the one just programmed, press Repla . BUTTON PROGRAMMED! is displayed.
 - To keep the existing function and forget the function just programmed, press Keep .
 - To delete the existing function and forget the function just programmed, press Delet .

7.5 Longhand Programming



















1. Press  Admin. See [Display Key Programming](#) ⁵⁰.
2. To switch to longhand programming mode, press Expl? .
3. Press Next  until the required function required is shown, then press Selct .
4. If the function requires some data to be entered, [] is shown at the bottom of the display. Enter the data using the normal phone keypad. The upper part of the display reverts to showing the functions currently assigned to  and .
5. To move between the pages of display keys, press  and .
6. To select the display key against which to program the new function, press  or .

Caution

 - Do not select the slot used for the Admin function. Replacing this function will lock the phone for further programming until reset through the phone system.
7. If the display slot is not already used, the display shows BUTTON PROGRAMMED!.
 - To end programming, press  EXIT.
 - To continue programming other functions, press  Cont.
9. If the display slot already has a programmed function, the display shows FEATURE ON BUTTON. Repla, Keep and Delet are shown along the right-hand edge of the display.
 - To replace that existing function with the one just programmed, press Repla . The display then shows BUTTON PROGRAMMED! as above.
 - To keep the existing function and forget the function just programmed, press Keep .
 - To delete the existing function and forget the function just programmed, press Delet .

7.6 Changing Function Key Labels

You can replace the default label shown for any function key with your own custom label of up to 13 characters.

1. To exit any other mode, press  EXIT and then press  Label.
 -  Edit allows you to replace the current labels, see the steps below.
 -  Inspect displays the default labels.
 -  Restore replaces any custom labels with the default labels.
 -  Done exits the button labelling options.
2. Press  Edit.
3. Select the function key whose label you wish to change.
4. Begin entering the New Label text using the phone keypad:
 - Each number key is marked with the letters it provides. You may have to press the key more than once depending on the character required. For example, the key 6 is also marked as M, N and O. To enter an O, re-press the 6 key until an O is displayed.
 - If the next character you want is on another key, simply key the next character.
 - If the next character you want to enter is on the same key just used, press  to move the cursor right and then enter the character.
 - Press * once enters a . (period). Pressing it twice enters a * (asterisk).
 - Press # once enters a - (dash). Pressing it twice enters a # (hash).
 - By default the first letter entered and the first letter after any space are entered in upper-case whilst all other characters are entered in lower-case. To change the case of the current character, press  Case.
 - To enter a space, press  Space.
 - To move the cursor one space right, press .
 - If you make a mistake, press  Backspace to delete the character to the left of the cursor.
 - If you have made a mistake in the middle of a character string and do not wish to backspace and re-enter all the characters, press  to step back to one character before the point where you wish to edit. Either insert the new character or press  Backspace to delete the character to the left of the cursor.
 - To delete all the current text, press  Clear.
5. When the new name is set as required, press  Save. To return to the label options screen without saving the changes, press  Cancel.
6. Select another button to re-label or press  Done.

Chapter 8.

System Features

8. System Features

8.1 Introduction

As well as accessing specific features on your phone, you can access a number of system features by dialling short codes.

These instructions are for the system's default configuration. They assume that you are using the default feature codes. It also assumes that you have full access to all features and the public phone network.

8.2 Ring Back

If your system administrator has allocated you the *Ring Back When Free* feature and you call an extension that does not answer or is busy, you can:

1. Press  RBak to set a callback on that extension. When the extension you called becomes free, your phone will ring (a burst of three rings).
2. Lift the handset and the extension is called automatically.

8.3 Call Forwarding

Your calls can be forwarded to another extension or an external number when:

- You are away from your desk (on no answer).
- Your extension is busy (on all Call Appearance keys).
- You are away from the office (e.g. when you are on holiday).

The following options are available for call forwarding:

- To set the number to which your calls are forwarded, dial *07*201# (forwarding to 201 in this example).
- To switch Forward Unconditional On (i.e. not Hunt Group), dial *01. The letter D is displayed. To switch it off, dial *02.
- To switch Forward On Busy On, dial *03. To switch it off, dial *04.
- To switch Forward On No Answer On, dial *05. To switch it off, dial *06.
- To switch Forward Hunt Group Calls On, dial *50. To switch it off, dial *51. This setting is for Forward Unconditional only.
- To Cancel All Forwarding, dial *00.

Note

- Cancelling all forwarding will also cancel any Diverts you have set.

8.4 Diverting Calls

You can divert your calls to another extension using Follow Me. Unlike Forward, Follow me can only be used to divert calls to another internal extension on the same IP Office.

Note

- If you do not answer calls at the temporary extension, they are forwarded to your own voicemail or call forwarding number.

To use Follow-Me-Here from another extension:

In this case, N is your home extension

- Dial *12**N*# from the extension you are temporarily using.
- Dial *13**N*# to re-direct the calls back to your own extension, before you return to it.

To use Follow-Me-To from your home extension:

In this case, N is the extension to which you want your calls diverted.

- Dial *14**N*# from your own extension.
- Dial *14*# to cancel either feature from your own extension.

Notes

- If you use the option [Cancel All Forwarding](#)⁽⁵⁶⁾, your Follow Me will also be cancelled.
- Follow Me does not apply to the following call types:
 - Voicemail Callback
 - Automatic Call Back
 - HOLD or Park return.

8.5 Do Not Disturb

You may choose to receive no calls at all or only those from particular callers on your exceptions list:

- To switch Do Not Disturb on (with or without exceptions), dial *08. An N is displayed. To switch it off, dial *09.
- To add a number to the exception list, dial *10*N#.
- To delete a number from the exception list, dial *11*N#.

Note

- Your callers, other than your exceptions, either hear busy tone or are re-directed to your voicemail.
- The only call that will ignore the Do Not Disturb rule will be one where you were the original caller, then performed an unsupervised transfer to another extension. If that extension does not answer, the call will be re-directed to you as the originator.

8.6 Parking Calls

You can park one or more calls; allowing you to make and receive other calls. You can also arrange for the parked call to be retrieved by another extension.

The system only allows calls to be parked for a short while before reconnecting them to the user who parked the call; the default setting is 5 minutes. Once the set time is reached, the parked call will ring back if your extension is idle.

Note

- To park a call using the short codes, the call must first be put on [Hold](#) ⁽²⁰⁾.

To park a call to be picked up by any extension:

- Dial *37*N# - Where N is the slot id you have assigned.
Inform your colleagues of the parked call and the slot id you have assigned.

To Un-park a call from another extension:

- Dial *38*N# - Where N is the assigned slot id.

To Park a call to your local extension:

- Dial *37#
When you park a call to your local extension, it is automatically given a slot id number based on your extension number followed by 0. If you park another call, it is given your extension number followed by 1 and so on up to 9. For example: if your extension is 201, the first parked call will be given the slot id 2010.

To Un-park a call on your local extension:

- Dial *38*# - If you have more than one call parked, the call parked first will be the first call to be un-parked

Note

- Feature keys can be setup to park and un-park calls. If required, contact your administrator.

8.7 Voicemail

You can enable voicemail to allow callers to leave messages when you are out of the office, away from your desk or engaged on another phone call. Voicemail messages can be retrieved internally or externally via any phone. Your voicemail may be set up to deliver your messages by calling you whenever you hang up: this feature is known as *Voicemail Ringback*.

Note

- Not all systems support voicemail or have voicemail installed.

The following options are available for voicemail:

- To switch voicemail on, dial *18. To switch it off, dial *19.
- To retrieve your voicemail, dial *17.
- To turn Voicemail Ringback on, dial *48. To turn it off, dial *49.

Dialling a number while listening to your messages invokes further facilities:

- Once messages have been delivered, they are held on the system for 24 hours (this is fixed for Voicemail Lite, but can be varied by your system administrator if your IP Office is equipped with VoicemailPro).
- You can collect your voicemail from another extension by using the PIN your system administrator has set up for you. You can collect your messages if you are out of the office, by either dialling from a number that has been registered for the purpose or by dialling your extension number and PIN when prompted. If validation is successful, then dial 2 to retrieve your mail.
- The system administrator also specifies the reception number, to which the call is diverted if the caller dials 0, and your email address if your voicemail and email are integrated.

8.8 Default Feature Codes

The following are the normal default feature codes available to all users. Your system administrator may add additional codes for other features and for speed dials.

The N, where shown, should be replaced by the appropriate number. For example, with *07*N#, replace N with the extension to which you want your calls forwarded when you have forwarding switched on.

*00	Cancel All Forwarding	*32*N#	Call Pick Up Extension
*01	Forward Unconditional On	*33*N#	Call Queue
*02	Forward Unconditional Off	*34	HOLD Music
*03	Forward On Busy On	*35*N#	Extn Login
*04	Forward On Busy Off	*36	Extn Logout
*05	Forward On No Answer On	*37*N#	Park Call
*06	Forward On No Answer Off	*38*N#	Ride Call
*07*N#	Forward to Number	*39	Relay On
*08	Do Not Disturb On	*40	Relay Off
*09	Do Not Disturb Off	*41	Relay Pulse
*10*N#	Do Not Disturb Exception Add	*42	Relay On
*11*N#	Do Not Disturb Exception Delete	*43	Relay Off
*12*N#	Follow Me Here	*44	Relay Pulse
*13*N#	Follow Me Here Cancel	*45*N#	Call Steal
*14*N#	Follow Me To	*46	Call Steal
*15	Call Waiting On	*47	CONFERENCE Add
*16	Call Waiting Off	*48	Voicemail Ringback On
*17	Voicemail Collect	*49	Voicemail Ringback Off
*18	Voicemail On	*50	Forward Hunt Group Calls On
*19	Voicemail Off	*51	Forward Hunt Group Calls Off
*20*N#	Set Hunt Group Night Service	*52	Clear Call
*21*N#	Clear Hunt Group Night Service	*53*N#	Call Pickup Members
*29	Toggle Calls	*57*N#	Forward on Busy Number
*30	Call Pick Up Any	*70*N#	Dial Physical Extn by Number
*31	Call Pick Up Group	*71*N#	Dial Physical Extn by ID

Chapter 9.

EU24 Expansion Module

9. EU24 Expansion Module

9.1 EU24 Overview

The EU24 Expansion Module is an optional device that can be connected to your 2420/5420 phone to extend the number of call appearance and feature buttons available on the phone.

The expansion module has 24 buttons arranged in two columns. Depending on how they have been programmed by your system administrator, these buttons can be used for call appearances or features. You can adjust the viewing angle of the EU24 display to match that of your phone.

The following figure shows a top view of the EU24 (the left hand column is displayed).

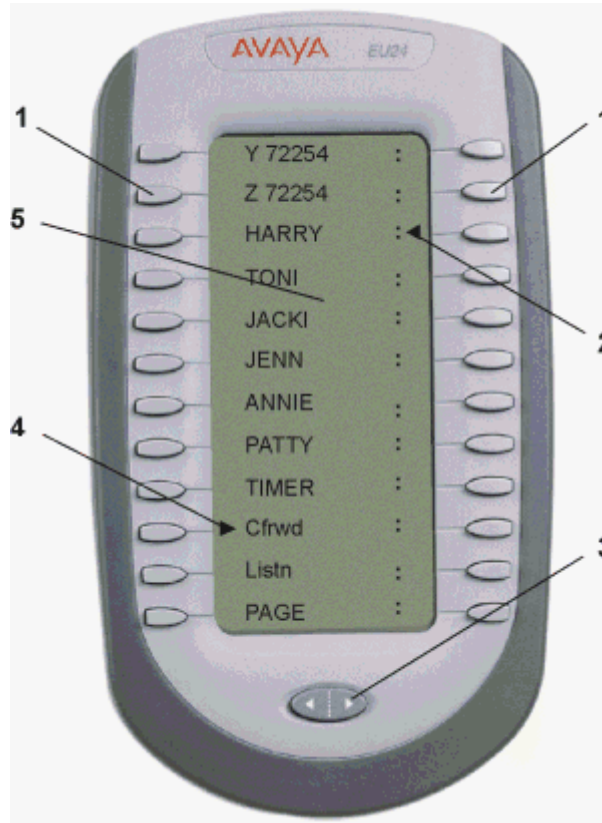

1. Call Appearance/Feature Button.
2. Feature Active icon for feature in right column.
3. Alternate Display Button.
4. Feature Active icon for feature in left column.
5. Display.

9.2 Connection

Before you can begin using the EU24 Expansion Module, the module must be connected to the phone according to the instructions in the *EU24 Expansion Module Installation and Safety Instructions (555-233-136)*.



9.3 Using the EU24 Expansion Module

The following section explains how to use the features of the EU24 Expansion Module. For more information, consult your system administrator.

Viewing the Alternate Display:

Although the EU24 Expansion Module supports an additional 24 call appearance/feature keys, it only displays the key labels and icons for one column at a time. A dotted line separates the left column from the right column.

When you are viewing the labels and icons for the left column, the icons for the right column are displayed to the right of the dotted line. To view the column not currently displayed, press the Alternate Display button.

Selecting a Call Appearance/Feature Key:

To select an available call appearance or feature, press the button next to the label in the column currently displayed.

If the call appearance or feature is not currently displayed, press the Alternate Display button to access the additional 12 call appearance/feature button labels.

Understanding Call Appearance/Feature Key Status Icons:

When a call arrives for a call appearance on the EU24 Expansion Module, the bell icon blinks on the corresponding call appearance. To answer the call, press the associated call appearance button.

The icons displayed on the call appearance allow you to determine the status (for example, on hold) of each call on the EU24 Expansion Module. Icons also indicate whether a feature has been administered for a particular button on the EU24 Expansion Module.

Index

A

Adding 25
 Adding,New Speed Dial 25
 Adjusting 43
 Adjusting,Display Contrast 43
 AGC 45
 All Logged Calls 39
 All Logged Calls,Erasing 39
 Answer 14
 Answer,Call 14
 Automatic Gain Control 45

B

Back 56

C

Call 14, 15, 38, 58
 Call Appearance Keys 8
 Call Appearance Keys Icons 9
 Call Forwarding 56
 Call Log 36, 37, 38
 Call Log Entry 26, 38, 39
 Call Log Entry,Converting 26
 Call Log Entry,Deleting 39
 Call Log Entry,Saving 38
 Call Log Setup 43
 Call Log,Overview 36
 Call Log,Viewing 37
 Call,Answer 14
 Call,Clearing 15
 Call,Make 15
 Call,Making 38
 Call,Parking 58
 changing 31, 32, 42, 54
 changing,Function Key Labels 54
 changing,Your Greeting 31
 Changing,Your Mailbox Password 32
 Clearing 15
 Clearing,Call 15
 conference 8, 11, 16
 Connection 63
 Converting 26
 Converting,Call Log Entry 26

D

Default Feature Codes 60
 Default Phone/Eraser All Settings 44
 Deleting 26, 39
 Deleting,Call Log Entry 39
 Deleting,Speed Dial 26
 Dialling 26
 Dialling,Speed Dial Number 26
 Display 11
 Display Contrast 43
 Display Contrast,Adjusting 43
 Display Mode 49
 Divert 57

E

Editing 26
 Editing,Speed Dial 26
 Email Alerts 33
 Erasing 39
 Erasing,All Logged Calls 39
 EU24 Expansion Module 63
 EU24 Expansion Module,Using 63
 EU24 Overview 62

F

Function Key Labels 54
 Function Key Labels,Changing 54
 Function Key Programming 50
 Function Keys 48
 Function Keys,Overview 48

H

Headset Working 17
 hold 8, 14, 17, 20, 44, 63

L

Language 45
 Listen 29
 Listen,Vocemails 29
 Logged 10, 37
 Logged,Off 10
 Logged,On 10
 Longhand Programming 53

M

Making 15, 38
 Making,Call 15
 Making,Calls 38
 Message 21
 Miscellaneous 43
 Mute 20

N

New Speed Dial 25
 New Speed Dial,Adding 25
 Not Disturb 58

O

Off 10
 Off,Logging 10
 On,Logging 10
 Overview 24, 28, 36, 48
 Overview,Call Log 36
 Overview,Function Keys 48
 Overview,Speed Dials 24
 Overview,Visual Voice 28

P

Parking 58
 Parking,Calls 58
 Private Call 21

R

Redial 19
 Ringer Options 42

S

Saving 38
 Saving,Call Log Entry 38
 Send 30
 Send,Vocicemail 30
 Setting 37
 Setting,Which Calls 37
 Shorthand Programming Mode 52
 Speakerphone 18
 Speed Dial 19, 24, 26
 Speed Dial Number 26
 Speed Dial Number,dialling 26
 Speed Dial,Deleting 26
 Speed Dial,Editing 26
 Speed Dial,Overview 24
 System Features 9
 System Features Introduction 56

T

Transfer 16

U

User 11
Using 63
Using Self Test 44
Using The Call Log 36
Using,EU24 Expansion Module 63

V

Viewing 37
Viewing,Call Log 37
Visual Voice 28
Visual Voice,Overview 28
Voicemail 30, 59
Voicemail TRANSFER 33
Voicemail,Send 30
Voicemails 29
Voicemails,Listen 29

W

Which Calls 37
Which Calls,Setting 37

Y

Your Greeting 31
Your Greeting,Changing 31
Your Mailbox Password 32
Your Mailbox Password,Changing 32
Your Speed Dial List 38

Performance figures and data quoted in this document are typical, and must be specifically confirmed in writing by Avaya before they become applicable to any particular order or contract. The company reserves the right to make alterations or amendments to the detailed specifications at its discretion. The publication of information in this document does not imply freedom from patent or other protective rights of Avaya or others.

Intellectual property related to this product (including trademarks) and registered to Lucent Technologies have been transferred or licensed to Avaya.

All trademarks identified by the ® or ™ are registered trademarks or trademarks, respectively, of Avaya Inc. All other trademarks are the property of their respective owners.

This document contains proprietary information of Avaya and is not to be disclosed or used except in accordance with applicable agreements.

Any comments or suggestions regarding this document should be sent to "wgctechpubs@avaya.com".

© 2009 Avaya Inc. All rights reserved.

Avaya
Unit 1, Sterling Court
15 - 21 Mundells
Welwyn Garden City
Hertfordshire
AL7 1LZ
England.

Tel: +44 (0) 1707 392200
Fax: +44 (0) 1707 376933

Web: <http://marketingtools.avaya.com/knowledgebase>